



PRODUCT OVERVIEW
FORGE[®] Nxt2.1



Thank you!

Dear clients,

Thank you for your trust in our software.

FORGE® NxT 2.1 introduces many innovative features that each user can take full advantage of. This document presents all the new developments and improvements provided by this release.

FORGE® NxT 2.1 is focused on a significant improvement of the graphical Interface:

- All 2D or 3D operations can now be defined in your forging sequence
- The user can select the language of his working environment for more efficiency

You can also see a radically simplified exploitation of your CAD files thanks to the partnership with Elysium / CADdoctor.

With FORGE® NxT 2.1, let's be creative and dare new designs!

Your TRANSVALOR team.



Programme

1

Integrating the 2D universe and enhancements: The advantages of the FORGE® NxT interface

All 2D features in older versions have been restored into the new interface.

2

CADdoctor TRANSVALOR Edition

A new asset to ensure simple and direct use of CAD design data for your calculations.

3

Improvements in ring-rolling

For the radial/axial rolling, the introduction of control loops for driving the conical roll makes the simulation even more accurate with the reality of the process.

4

Improved user experience

The latest options for graphical user interface for set-up and results analysis always more pleasant and efficient.

Integrating the 2D universe and improvement: The advantages of the FORGE[®] NxT interface

All 2D features from previous versions have been integrated into the NxT interface.

Now benefit from interface improvements to realize two-dimensional simulations for the manufacturing of your axisymmetric parts, but also for your 2D/3D hybrid forging sequence.

Your 2D & 3D process models can be accessed directly using the keywords '2D' & '3D'. Easy and quick access!

On the following pages, learn about the *improvements in features and user experiences* that have been made in the 2D universe:

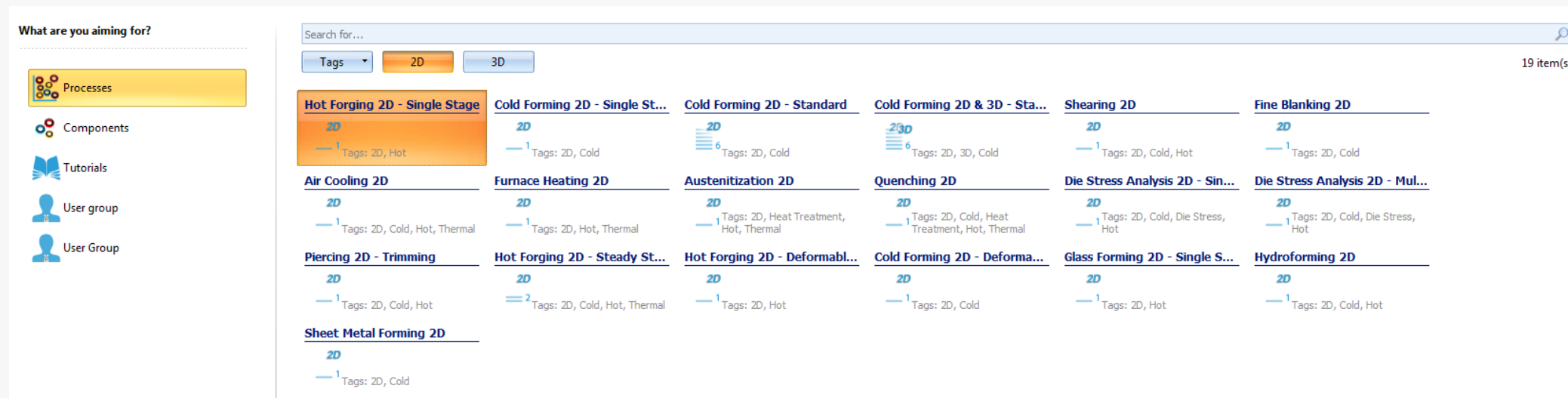

Access all your simulation models directly from the NxT interface.

Integrating the 2D universe and improvements: Complete forging sequence for axisymmetric part

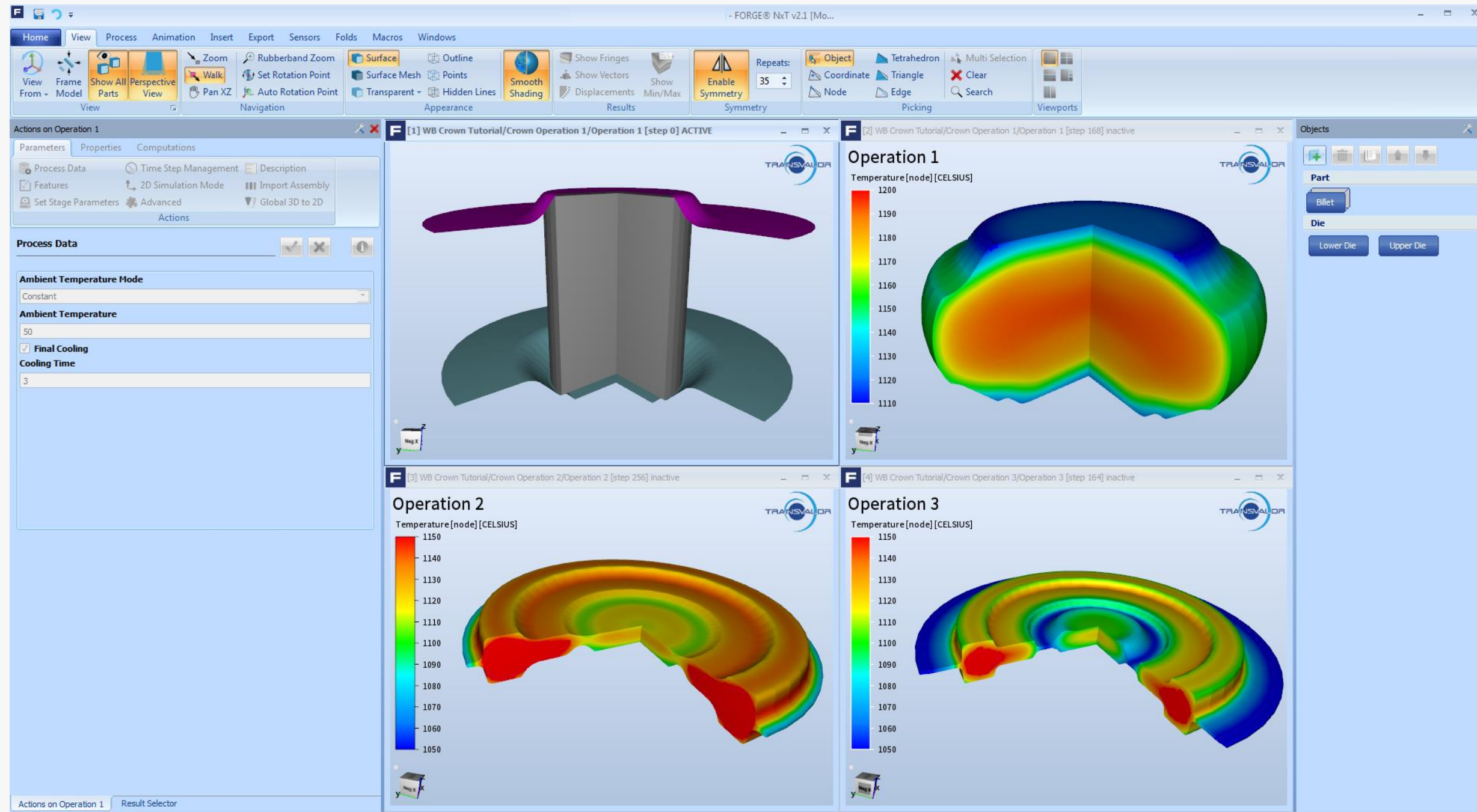

Integrating the 2D universe and improvements: The benefits of the NxT interface

Enjoy improved features and realize your transformation from 2D to 3D simulations using the « *2D to 3D Global Transformation* ».

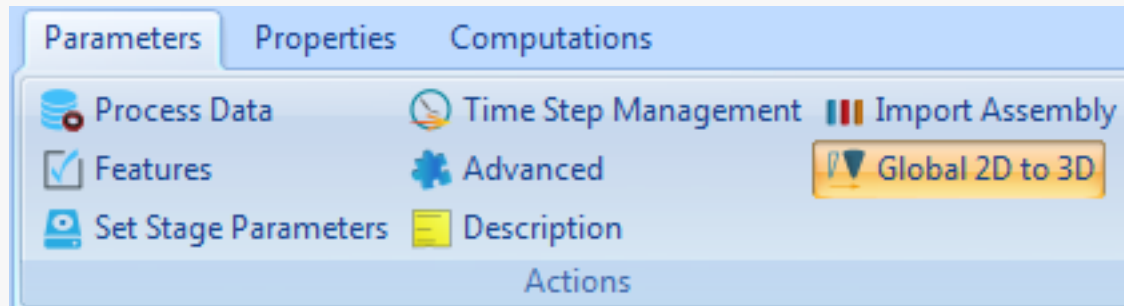

In a 3D simulation context, convert all your objects (part or dies) with a *single click*, which will be transformed from their original 2D format into a 3D geometry.

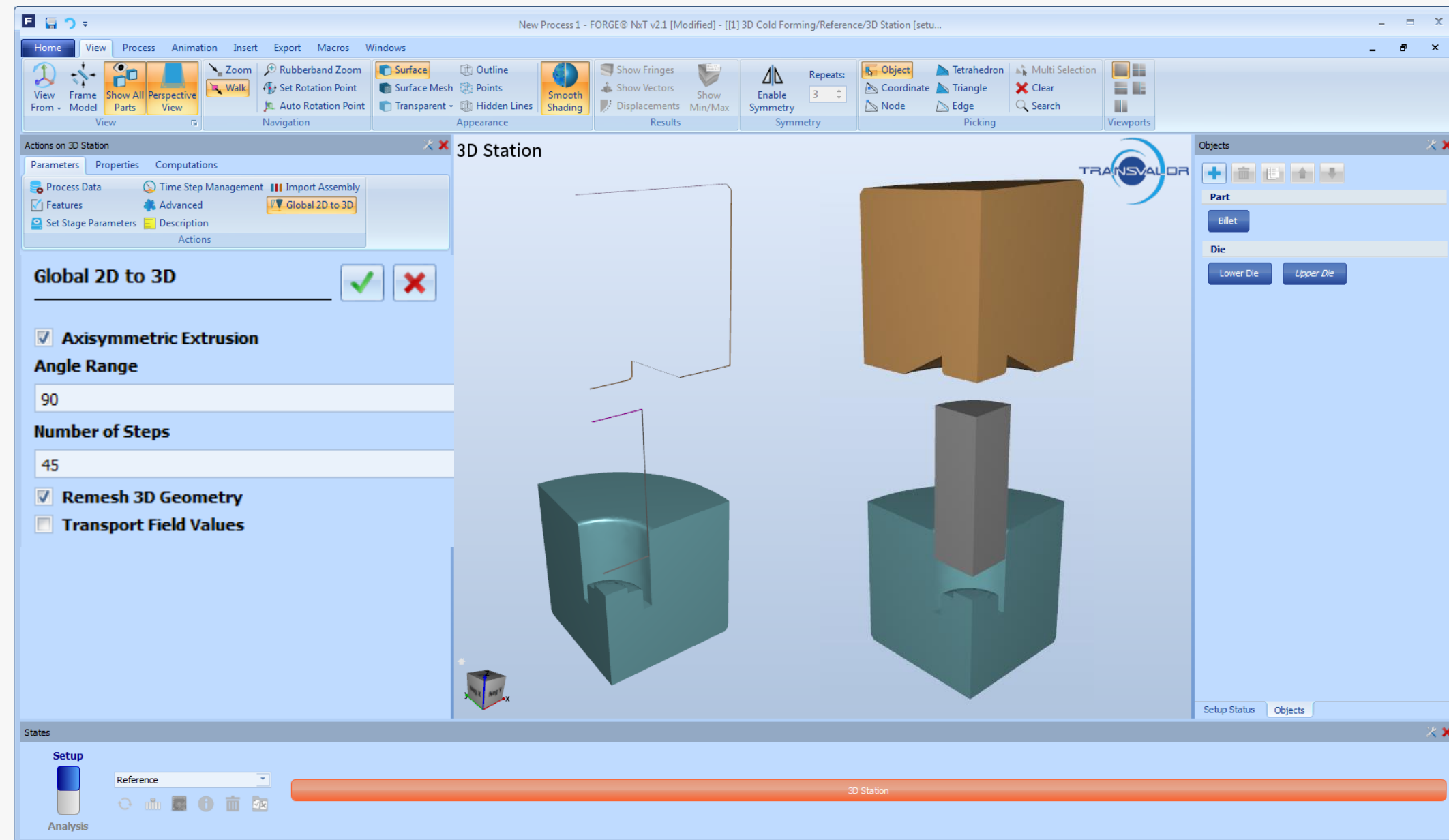

Integrating the 2D universe and improvements: The benefits of the NxT interface

Note also that the « *Stores* » are extended to include the 2D data.

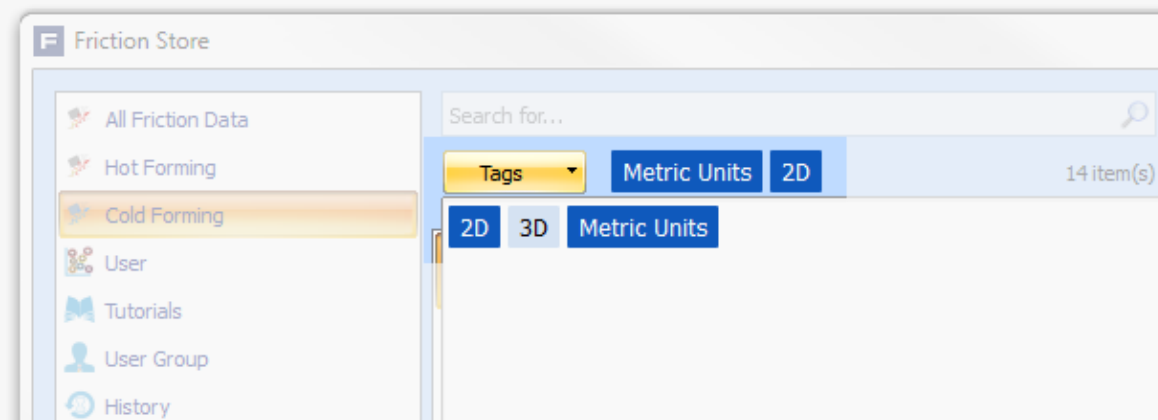

Thanks to the « *Filter system* », you can now quickly browse the stores and select your tutorials, geometries, friction files and heat exchanges, user variables and so on.

This is also applicable in the context of 2D simulation.

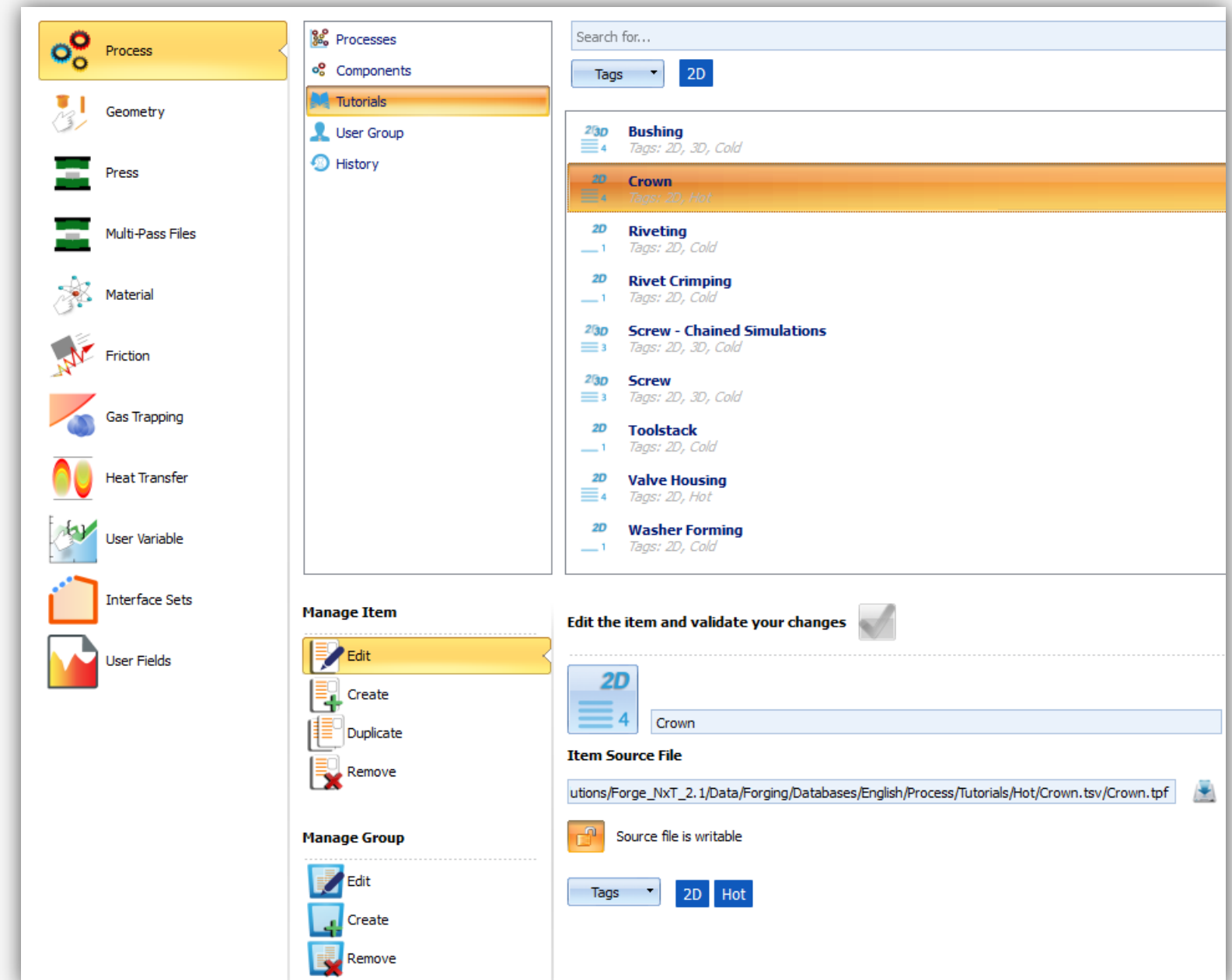

Integrating the 2D universe and improvements: 2D & 3D hybrid forging sequence

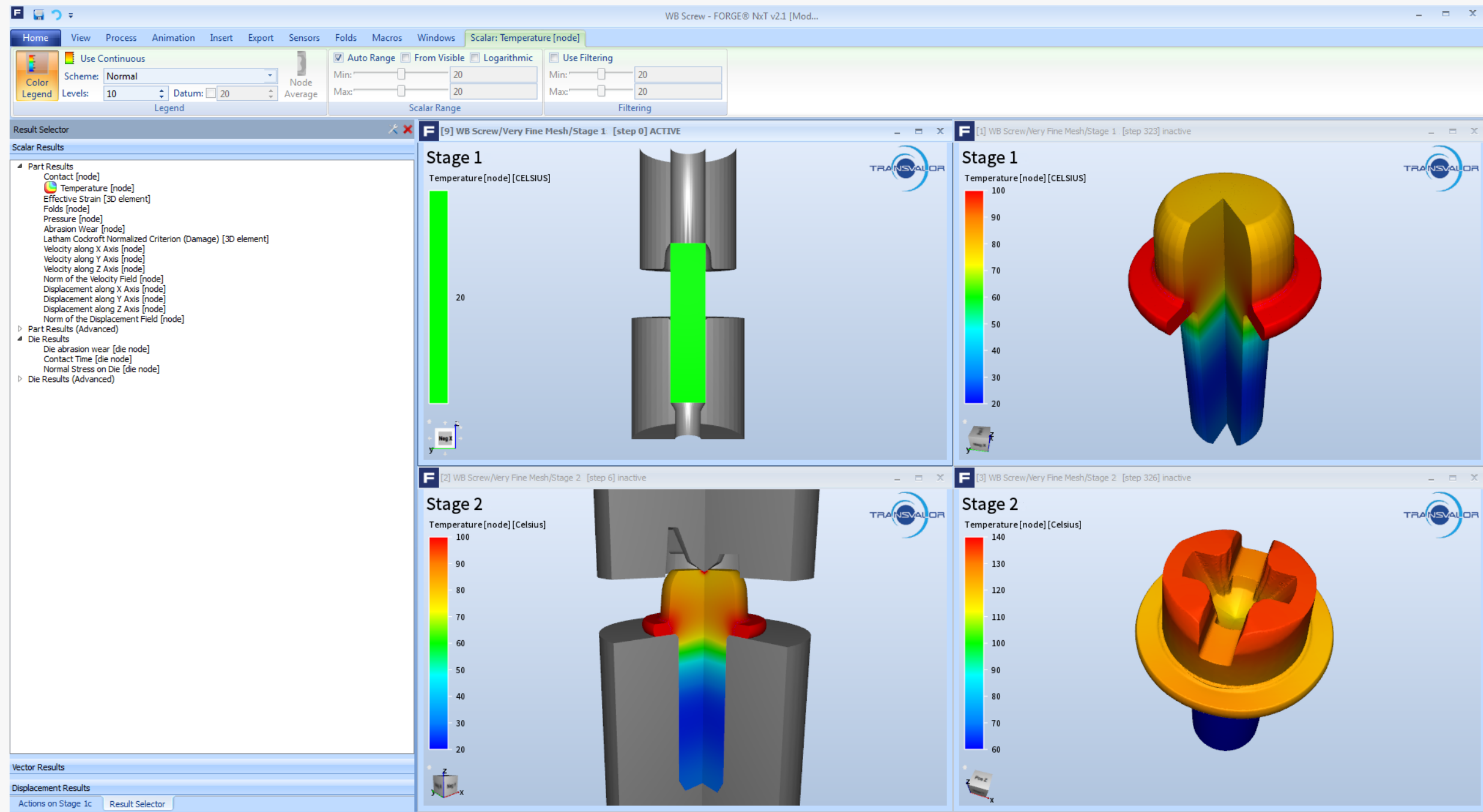

Integrating the 2D universe and improvements: The benefits of the NxT interface

Choose the « *2D View* » to operate your simulations with greater comfort. The view is oriented in the plane XZ without perspective to present the part in front view.

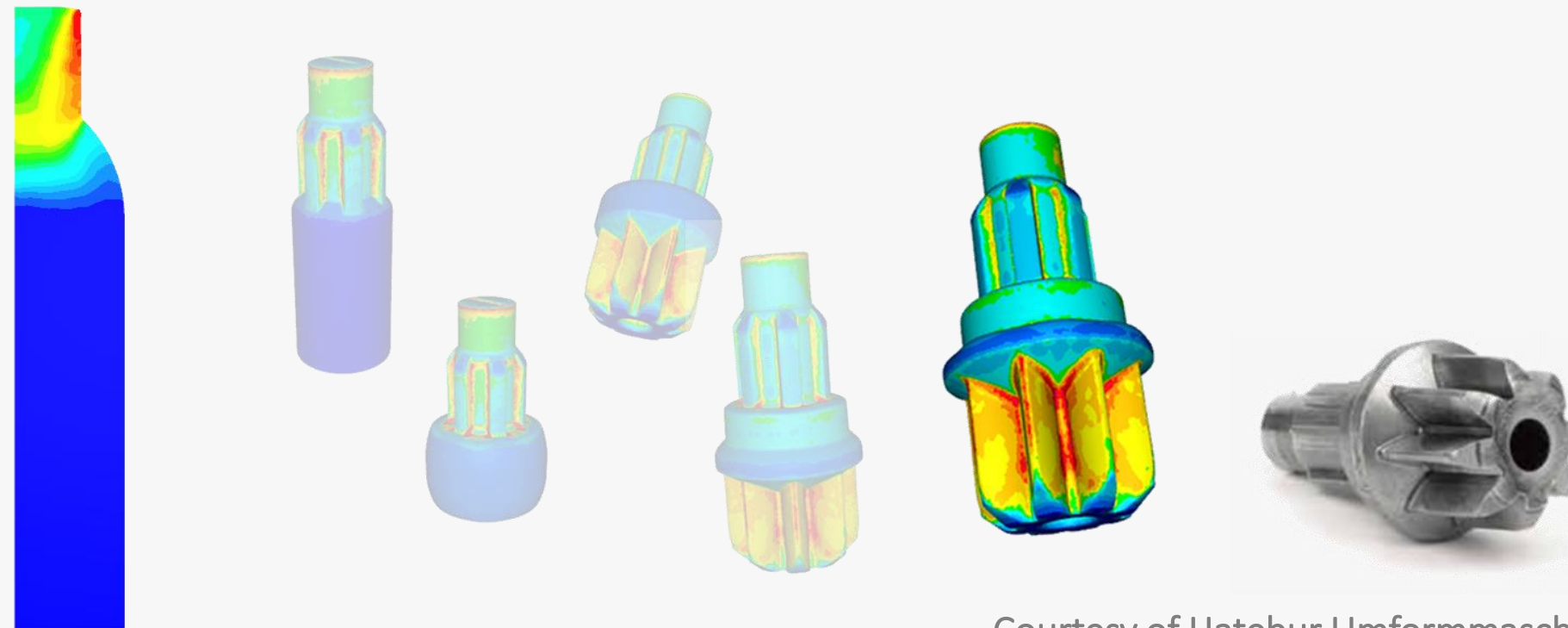
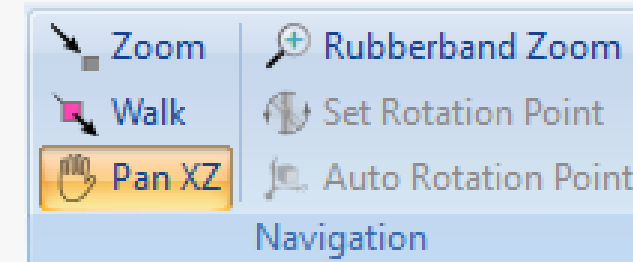

Courtesy of Hatebur Umformmaschinen AG

CADdoctor TRANSVALOR EDITION*

As a result of a partnership between Transvalor and Elysium, *CADdoctor TRANSVALOR Edition* was designed specifically for users of Transvalor solutions to improve data quality and interoperability.

CADdoctor TRANSVALOR Edition ensures:



- the import of CAD files in native format,
- fast and automatic correction of surface defects,
- the rapid and efficient simplification of unnecessary geometric details,
- an export of CAD data directly to the proprietary Transvalor format.

CADdoctor TRANSVALOR Edition allows:



- the direct and successful import of 3D models optimized in FORGE[®],
- a good topological quality meshing,
- the optimization of the meshes for a reduced computing time without downgrading the quality of the results.

*CADdoctor Transvalor Edition is an independent, licensed product. This product is not included by default in the FORGE[®] license or in the updates of the maintenance contract.



ELYSIUM

CADdoctor[®]

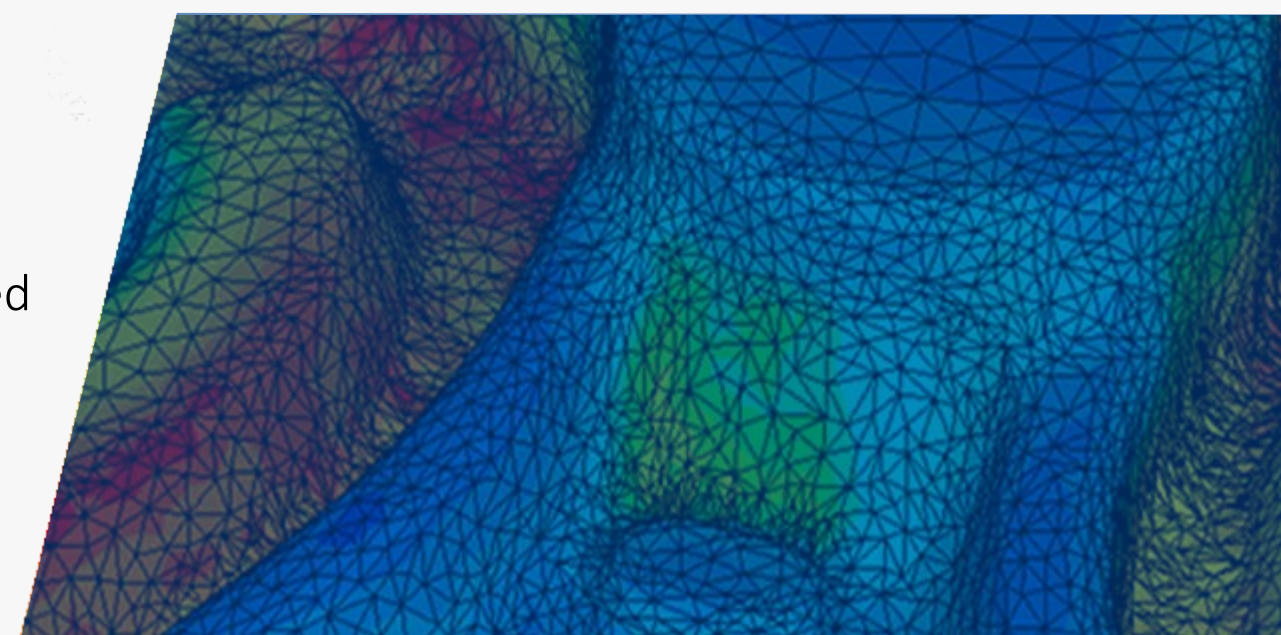

Improvements in ring-rolling

Improvements of the CARWIN-like piloting

FORGE® NxT 2.1 allows to go further in the representation of the kinematics of the ring-rolling by integrating improvements in the feedback loop:

- For the conical roll:
 - Possibility of specifying the maximum forces as a function of the position of the ring on the conical roll.
 - The possibility to release the conical roll at a given ring diameter.

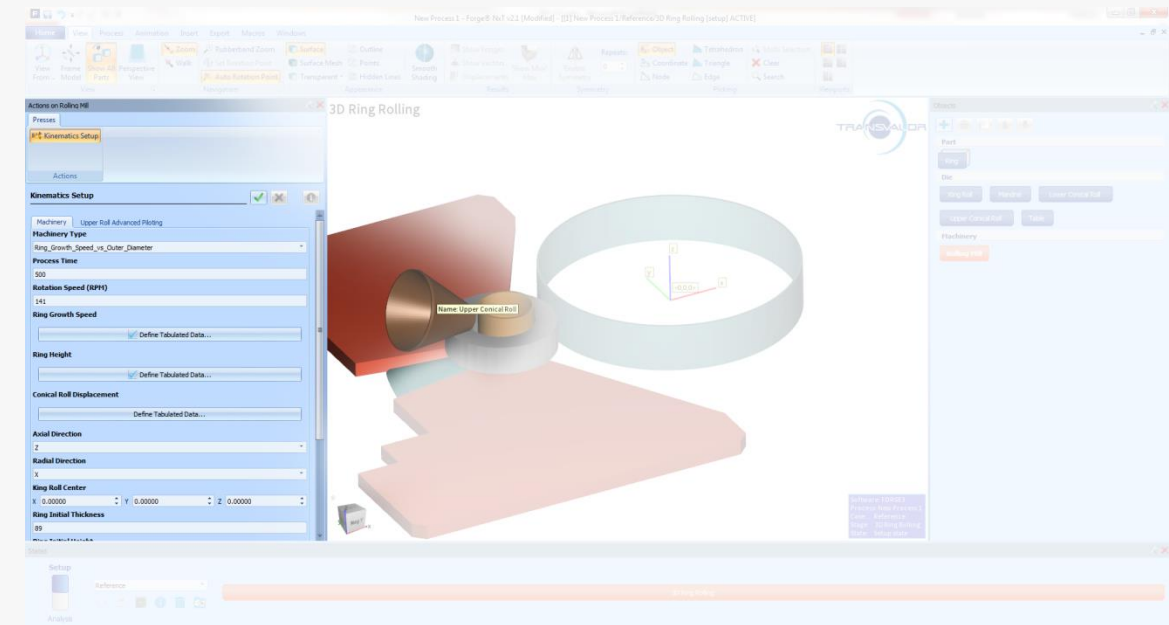

Rolling of non-axisymmetric parts

FORGE® NxT 2.1 allows to start a simulation of ring-rolling with a part that is not perfectly axisymmetrical, a piece resulting from a forging sequence for example.

Decoupled die stress analysis on dies in rotation

Particularly useful in ring rolling (horizontal or vertical) a decoupled die stress analysis can be performed on rotating dies for instance on the mandrel or on the king roll. This is also applicable on processes such as orbital forging or cross wedge rolling where any rotating tool can now be studied in a « decoupled » approach.

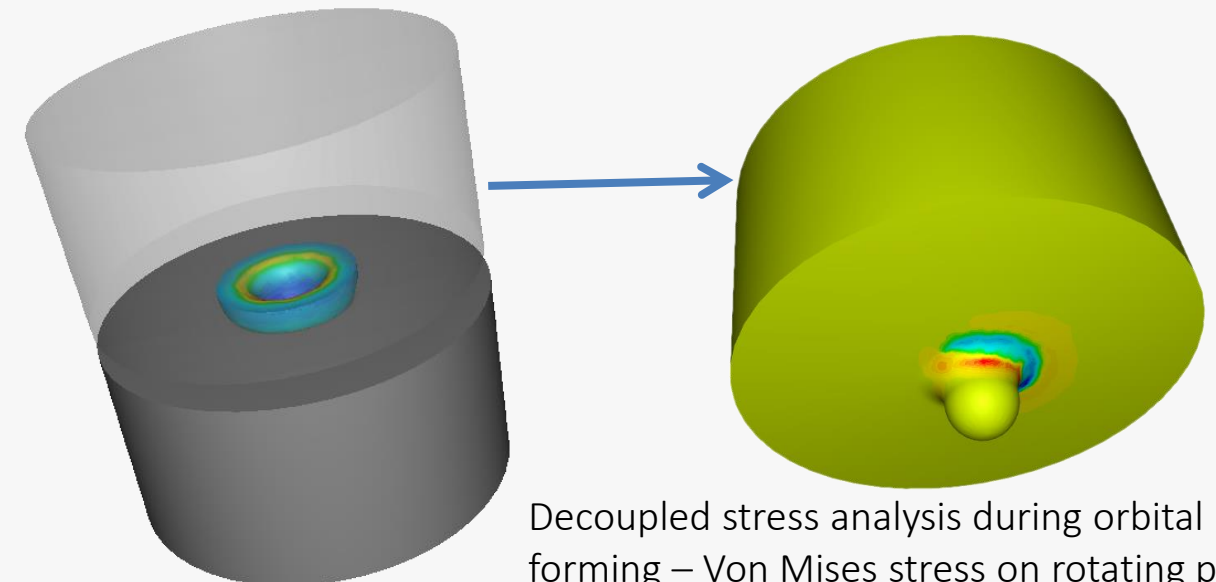

Decoupled stress analysis during orbital forming – Von Mises stress on rotating punch

Improved user experience

Multi-language interface

For greater efficiency, the NxT interface is now *available in several languages*: English, French, German and Japanese.

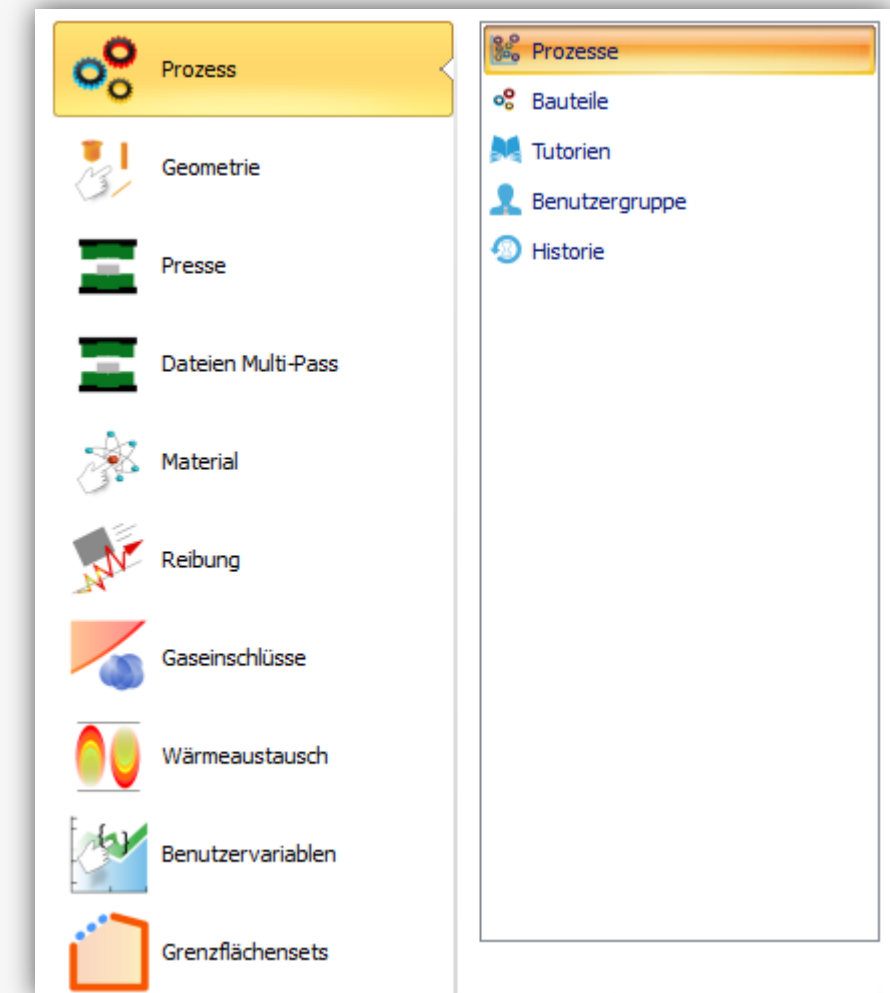
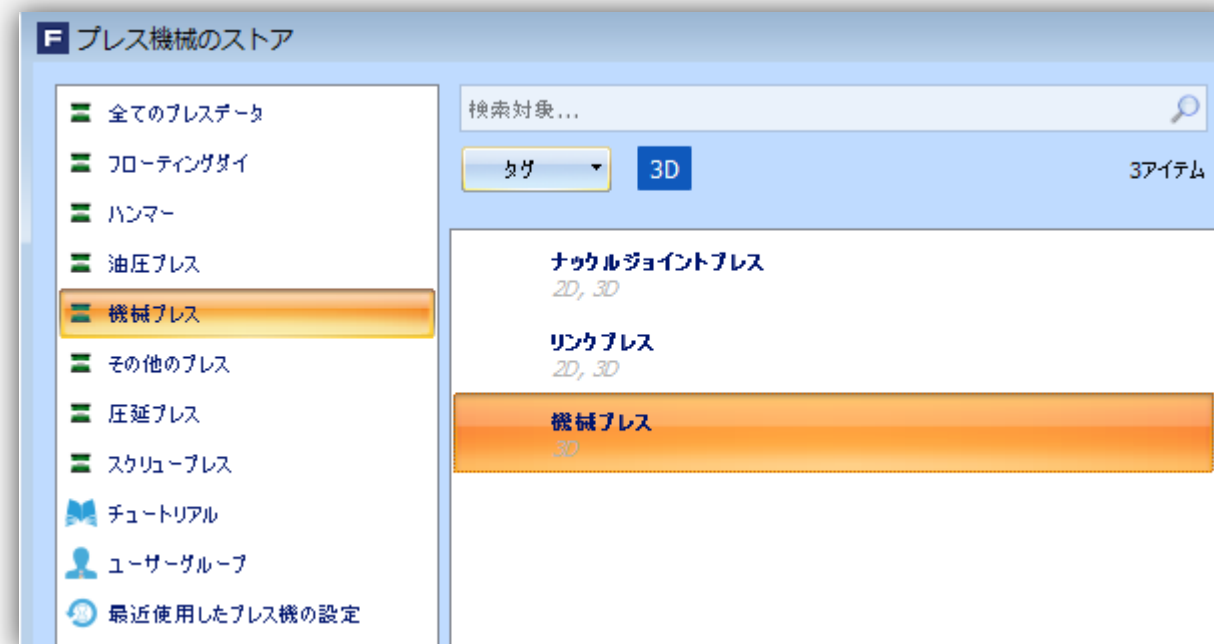
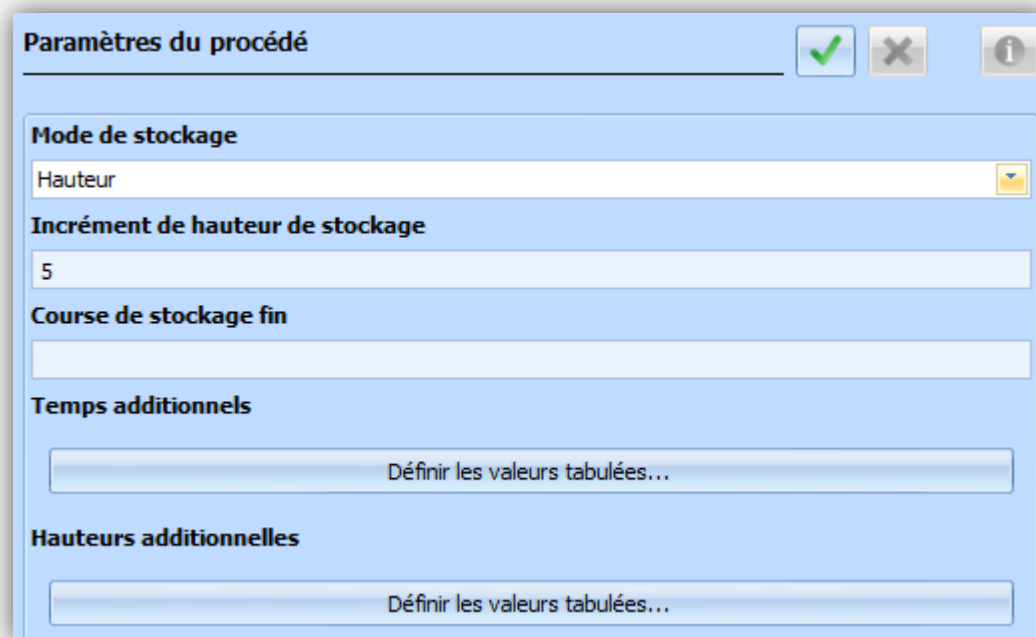
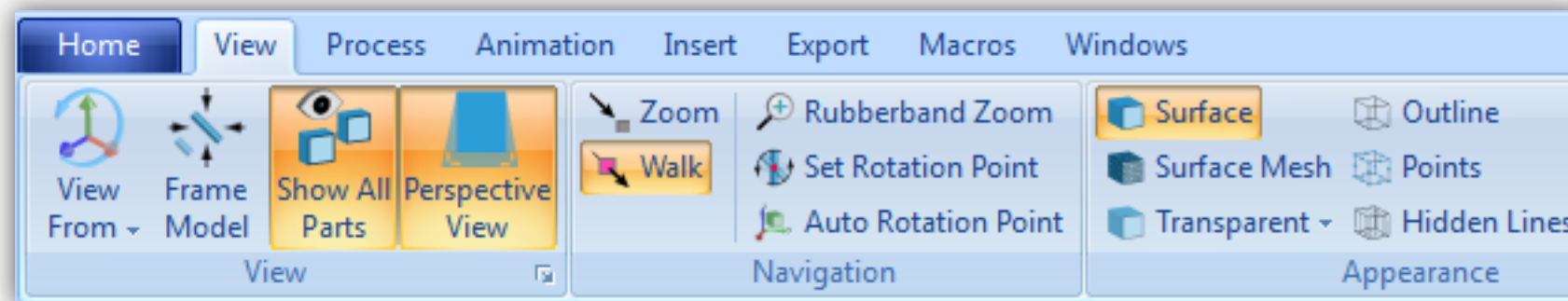
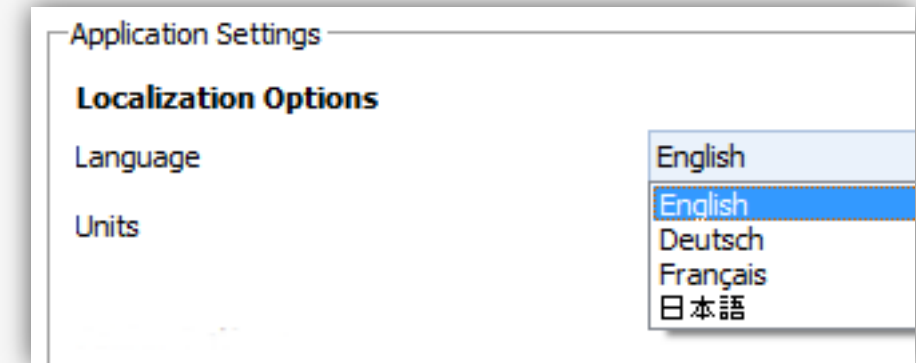

Improved user experience

Customization of the legend

The ability to set a legend value has been added.

This is useful for demonstrating *sensitive thresholds* (typically areas where the temperature or constraints would exceed limit values), but also to easily set up a *symmetric scale centered on 0*

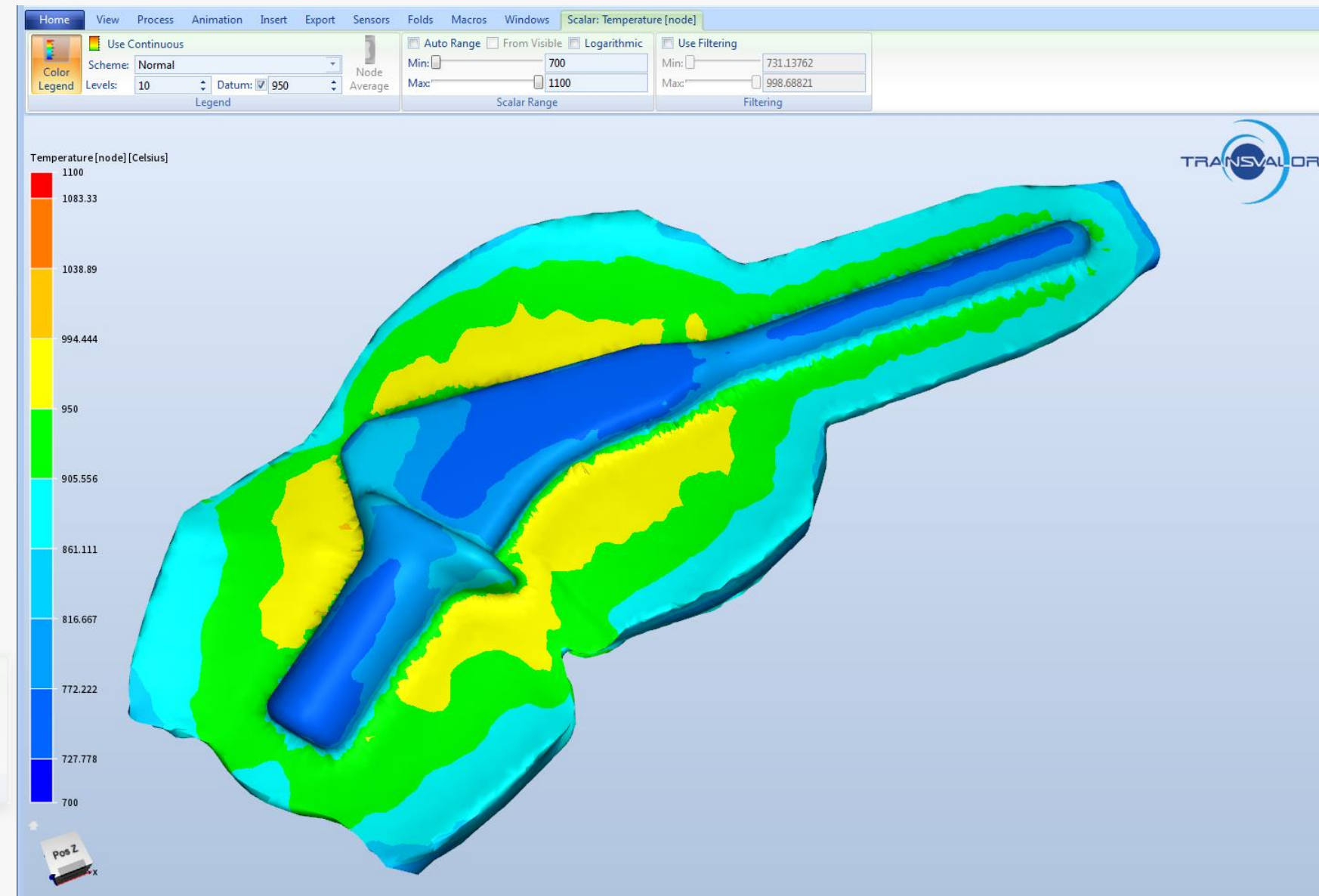
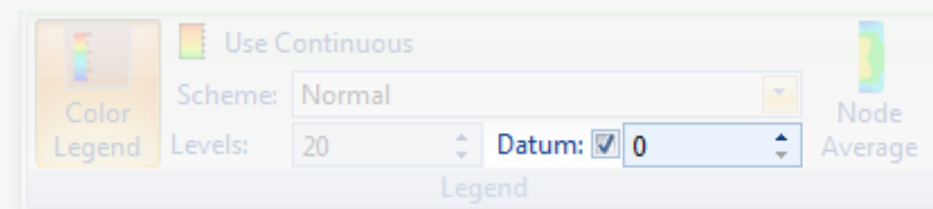
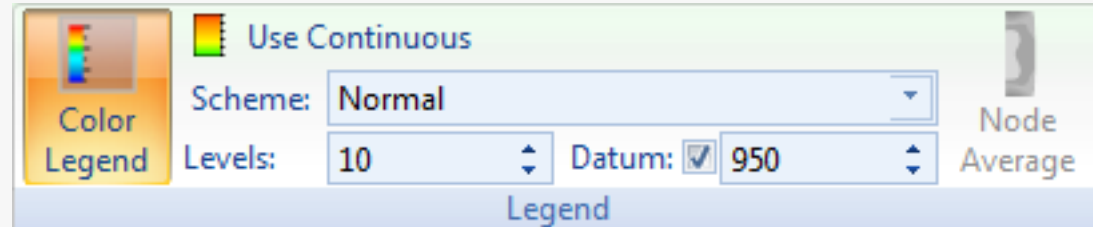

Titanium alloy forging with a threshold at 950°

Improved user experience

Rotation direction display

Arrows now indicate the direction of rotation of the tools for which a rotational kinematics has been defined. This display appears when the kinematics preview action is triggered.

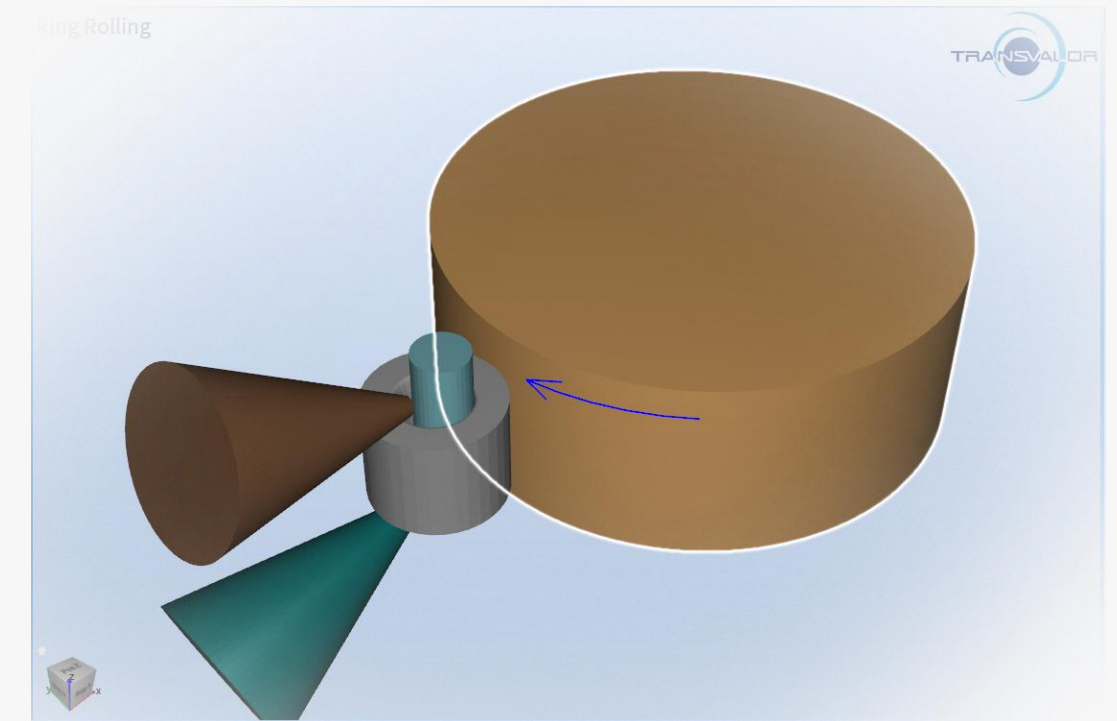
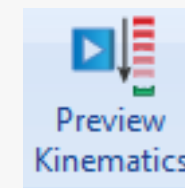
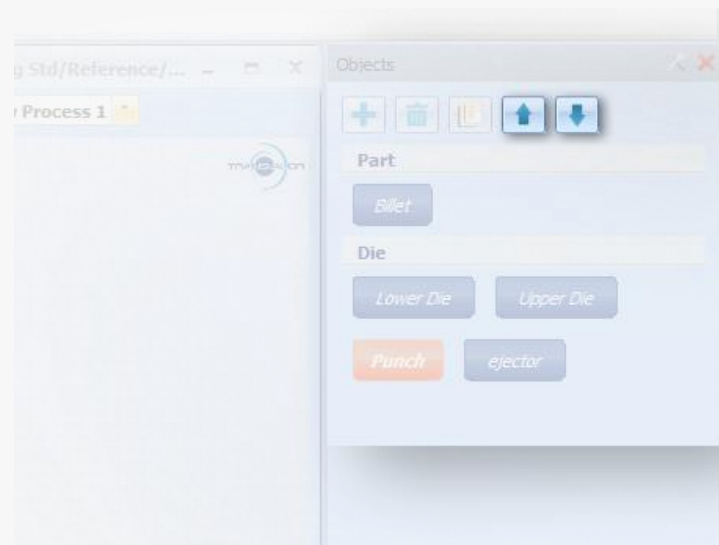

Possibility to reorder objects

The NxT interface offers the possibility of easily reordering objects. Very useful for improving the visibility of a data set with a large number of objects.

Improved user experience

Cancel the mesh generation ...

Who has never triggered the mesh generation with inadequate parameters?

Now a simple click  will allow you to cancel the current action and quickly return to the previous situation.

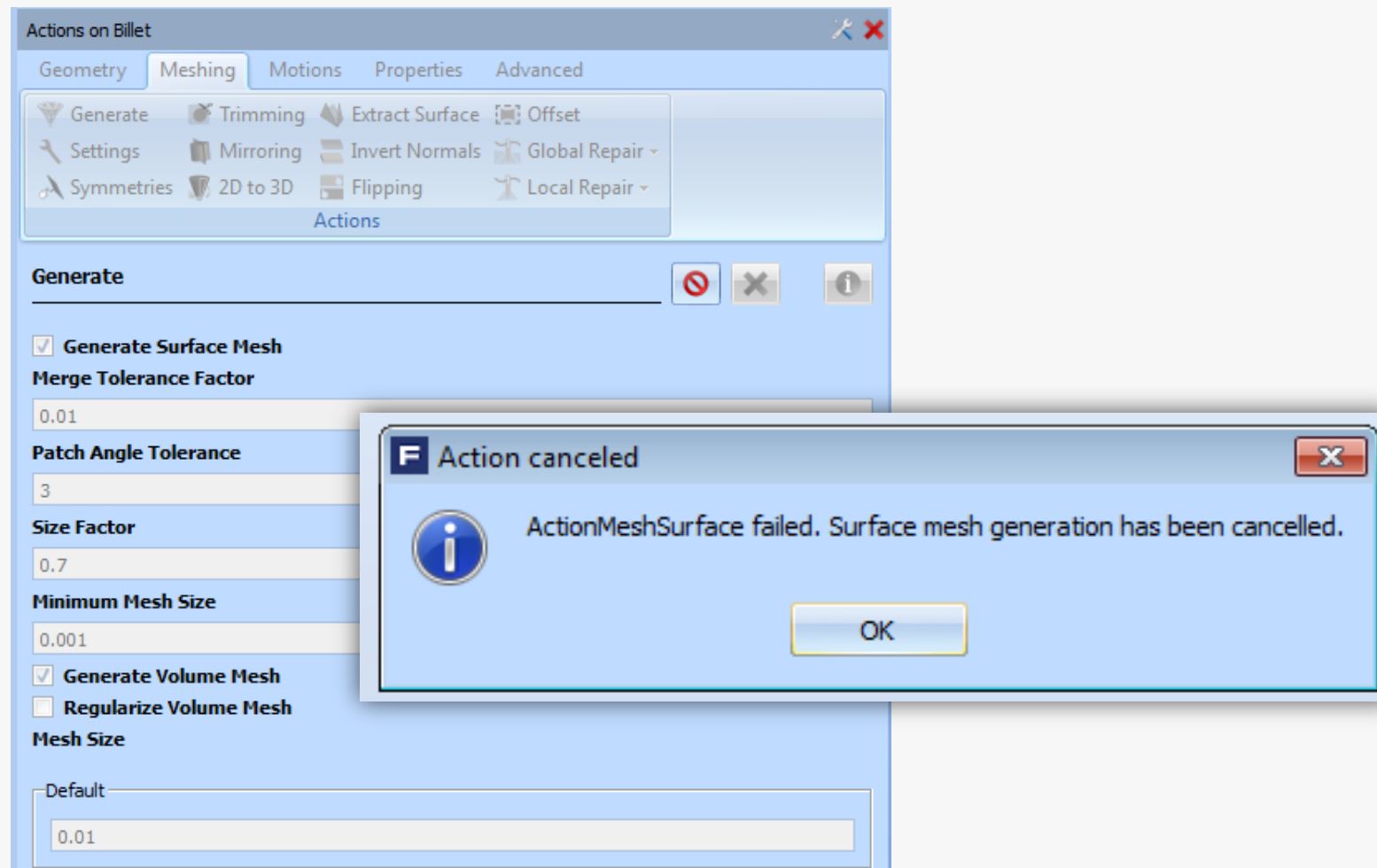

Cancel the animation setup ...

For the same reasons, you will appreciate being able to quickly stop the Animation Setup!

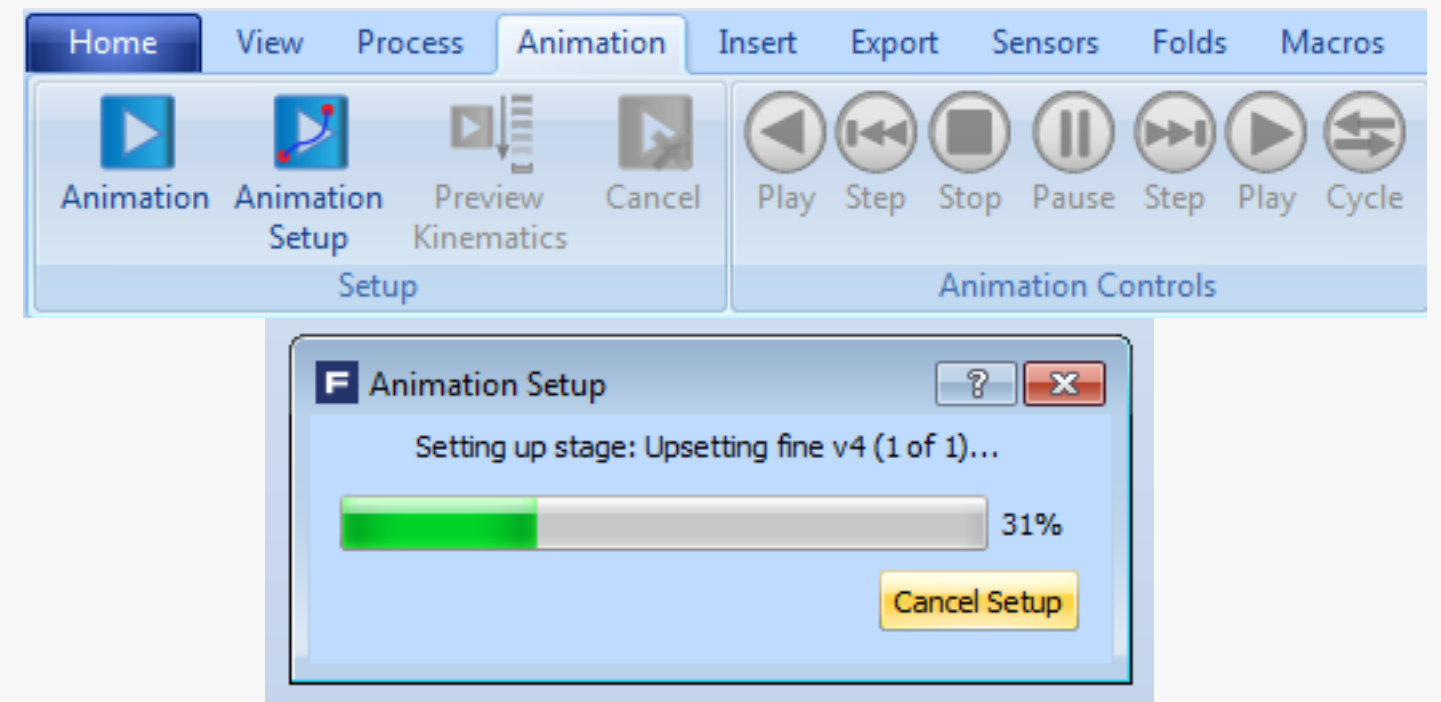



ADDRESS:

694, avenue du Dr. Maurice Donat - Parc de Haute Technologie
06255 Mougins cedex
FRANCE

CONTACT:

☎ +33 (0)4 9292 4200

📠 +33 (0)4 9292 4201

✉ marketing@transvalor.com

www.transvalor.com